

Table of Content 570800001

1. User manual	2
2. Legal regulations	2
3. Safety instructions	3
4. Controller functions	4
5. Functional principle	8
6. Technical data	9
7. Mounting	10
8. Mounting Principle	11
9. Dimensions (H x W x D)	12
10. Electrical connection	13
11. Wiring diagram	14
12. Taking into operation	15
13. Trouble shooting	15
14. Maintenance & Cleaning	15
15. Transport & Storage	16
16. Parts supplied	16



1. User manual

This instruction manual contains information and instructions to enable the user to work safely, correctly and economically on the unit. Understanding and adhering to the manual can help one:

- Avoid any dangers.
- Reduce repair costs and stoppages.
- Extend and improve the reliability and working life of the unit.

PLEASE ENSURE TO USE THE RIGHT VERSION OF THE INSTRUCTION MANUAL SUITABLE FOR YOUR UNIT.

Conditions of use

The unit is to be used exclusively for the dissipation of heat from control cabinets and enclosures in order to protect temperature sensitive components in an industrial environment. To meet the conditions of use, all the information and instructions in the instruction manual must be adhered to.



General danger

Indicates compulsory safety regulations which are not covered by a specific pictogram such as one of the following.



High electric voltage

Indicates electric shock danger.



Important safety instruction

Indicates instructions for safe maintenance and operation of the unit.



Attention

Indicates possible burns from hot components.



Attention

Indicates possible damage to the unit.



Instruction

Indicates possible danger to the environment.

2. Legal regulations

Liability

The information, data and instructions contained in this instruction manual are current at the time of going to press. We reserve the right to make technical changes to the unit in the course of its development. Therefore, no claims can be accepted for previously delivered units based on the information, diagrams or descriptions contained in this manual. No liability can be accepted for damage and production caused by:

- Disregarding the instruction manual
- Operating error
- Inappropriate work on or with the unit
- The use of non-specified spare parts and accessories
- Unauthorised modifications or changes to the unit by the user or his personnel

The supplier is only liable for errors and omissions as outlined in the guarantee conditions contained in the main contractual agreement. Claims for damages on any grounds are excluded.

3. Safety instructions

Upon delivery the unit is already meeting current technical standards and can therefore be safely taken into operation. Only authorised personnel is allowed to work on the unit. Unauthorised personnel must be prohibited from working on the unit. Operating personnel must inform their superiors immediately of any malfunction of the unit.

Please note that before starting to work on or with the unit, a procedure must be carried out inside the cabinet on which the unit is to be mounted.

Before commencing work inside the cabinet, the control cabinet manufacturer's instruction must be read with regards to:

- Safety instructions.
- Instructions on taking the cabinet out of operation.
- Instructions on the prevention of unauthorised cabinet reconnection.

The electric equipment meets the valid safety regulations. One can find dangerous voltages (above 50 V AC or above 100 V DC)

- Behind the control cabinet doors.
- On the power supply in the unit housing.

The unit has to be operated according to the type plate and the wiring diagram, and must be protected externally from overloading and electrical faults via suitable protective devices such as ground fault protection breakers.



Danger through incorrect work on the unit

The unit can only be installed and maintained by technical competent and qualified personnel, using only supplied material according to the supplied instructions.



Danger from electrical voltage

Only specialised personnel are allowed to maintain and clean the unit. The personnel must ensure that for the duration of the maintenance and cleaning, the unit is disconnected from the electrical supply.



Attention

Damage to the unit through the use of inappropriate cleaning materials. Please do not use aggressive cleaning material.



Instruction

Damage to the environment through unauthorised disposal. All spare parts and associated material must be disposed according to the environmental laws.

4. Controller functions

The cooling unit is intended to be used as a complementary accessory to larger industrial equipment. The unit is used where heat needs to be dissipated from electrical control cabinets or similar enclosures in order to protect heat sensitive components. *It is not intended for household use.*

The unit has two completely separate air circuits which ensure that the clean cabinet air does not come into contact with the ambient air which may well be dirty or polluted.

Enclosure cooling units can dissipate large quantities of heat from sealed enclosures such as electrical enclosures into the ambient air and at the same time reduce the cabinet internal temperature to below that of the ambient air.

The unit can function without problems in extreme ambient conditions (e.g. dusty and oily air) with a standard operating temperature ranging between -40°C (-40°F) and +55°C (131°F).



Units can be ordered with an additional electrical cabinet heater. For the cooling capacities and environmental ratings please refer to the type plate data.

Controller



The display shows the temperature in the range of -50°C to +150°C (-58°F to +302°F). The temperature is displayed with resolution of tenths between -19.9°C and +99.9°C (-3.8°F to +211.8°F). During programming, it shows the codes and values of the parameters. The display also shows icons according to occurring events.

Display icons

Icon	Function	Description
1	Compressor relay active	
2	Alarm relay active	Flashes when activation is delayed or inhibited by protection times, external disabling or other procedures in progress
3	Heater relay active	
4	Ambient blower relay active	
	Alarm	Flashes when alarms are active
	Heating mode	Signals operation of unit in heating mode
	Cooling mode	Signals operation of unit in cooling mode
TEST	Text mode in progress	Activated only by manual procedure

Programming

The operating parameters can be modified using the front keypad. Access differs depending on the type of parameter. Access to configuration parameters is protected by a password that prevents unwanted modifications or access by unauthorised persons.

Setting cooling set point, St1:



1. Press "SET" and display should show St1 and then the pre-set value of St1. (default: +35°C / +95°F)
2. Reach the desired value by using ▲ or ▼.
3. Press "SET" again to save the new value of St1.

Setting heating set point, St2 (only for units supplied with internal heater):



1. Press "SET" twice slowly and display should show St2 and then the pre-set value of St2. (default: +5°C / +41°F)
2. Reach the desired value by using ▲ or ▼.
3. Press "SET" again to save the new value of St2.

Setting temperature units (°C / °F), low temperature alarm and high temperature alarm:



1. Press "PRG" button for 5 seconds to reach the modifiable parameter list.
2. Use ▲ or ▼ to reach the desired parameter:
 - C18 for temperature unit of measure
 - °C = 0
 - °F = 1
 - P25 for low temperature alarm threshold (default -10°C / +14°F)
 - P26 for high temperature alarm threshold (default +55°C / +131°F)
3. Press "SET" on the desired parameter to display the current value.
4. Use ▲ or ▼ to reach the desired value.
5. Pressing "SET" temporarily saves the new value and returns to the parameters list.
6. Repeat steps 2-5 to set other parameters.
7. Press "PRG" for 5 seconds to permanently save the new values.

Set Point	Parameter	Default	Range
Cooling	St1	35°C / 95°F	20°C - 50°C / 68 -122°F
Heating (for units with heater)	St2	5°C / 41°F	-20°C - 20°C / -4°F - 68°F
Low Temperature Alarm	P25	-10°C / 14°F	-50°C - P26 / -58°F - P26
High Temperature Alarm	P26	55°C / 131°F	P25 - 150°C / P25 - 302°F







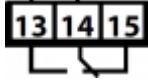

Test function

Different test functions can be used depending on the combination of keys pressed. Such tests run for the duration of 4 minutes.

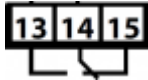
- “SET+▲” tests Compressor and Ambient Blower relays.
- “SET+▼” tests Alarms and Heater relays

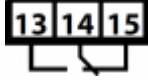
Alarm Relay Operation

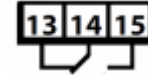
Both normally closed (NC) and normally open (NO) alarm contacts are provided. Under normal conditions, the NC contact is closed and the NO contact is open. When an alarm condition is present, the NC contact will open and the NO contact will close.

State	Alarm relay	Display
1 System powered OFF		
2 System powered ON - NO ALARM - Door Contact Closed		
3 System powered ON - Door Contact Open		
4 System powered ON - ALARM STATE		

Notes:

State 2: Additional icons (1,3,4, Reverse, Direct, Test) depending on operation.

State 3: The display shows “OFF” alternating with the standard display.

State 4: The display shows “EXX” alternating with the standard display – at the same time, the alarm icon flashes.

Typical alarm codes:

Error Code	Description
E01	Probe B1 fault
E02	Probe B2 fault
E04	High temperature alarm
E05	Low temperature alarm

Important Notes

- Whilst programming, if no button is pressed for 10 seconds, the display starts flashing, and after 1 minute returns to the main display without saving changes.
- To increase scrolling speed, press and hold the ▲ or ▼ button for at least 5 seconds.
- When pressing “PRG” for 3 seconds, the firmware revision code is displayed for 2 seconds.
- When cleaning the controller panel, do not use ethanol, hydrocarbons, ammonia or their by-products. Use neutral detergents and water.
- In order to protect the unit’s components, minimum relay output on (3 or 7 minutes) and off (4 minutes) times and minimum time (7 or 11 minutes) between activation of the same relay output are applied.
- In case of digital inputs not configured, probes not fitted or configured, or St2 not enabled on the controller the display shows ‘nO’.

5. Functional principle

The cooling unit for enclosures works on the basis of a refrigeration circuit consisting of four main components: compressor (1), evaporator (2), condenser (3) and expansion device (4).

The circuit is hermetically sealed and R134a refrigerant circulates inside it (R134a is chlorine free and has an Ozone Destruction Potential [ODP] of 0 and a Global Warning Potential [GWP] of 1430). The compressor compresses the refrigerant (thus taking it to high pressure and high temperature), and pushes it through the condenser, where it is cooled by ambient air thus passing from the gas to the liquid state. At the liquid state it then passes through the capillary pipe being a much lower pressure the refrigerant arrived to the evaporator where it absorbs the necessary heat to change from liquid to gas state. The gas is then drawn back into the compressor completing the cycle.

- | | |
|-----------------------------|-----------------------------|
| 1. Air intake, cabinet side | 7. Radial fan, ambient side |
| 2. Radial fan, cabinet side | 8. Condenser |
| 3. Evaporator | 9. Air outlet, ambient side |
| 4. Air outlet, cabinet side | 10. Filter dryer |
| 5. Compressor | 11. Capillary pipe |
| 6. Air intake, ambient side | |

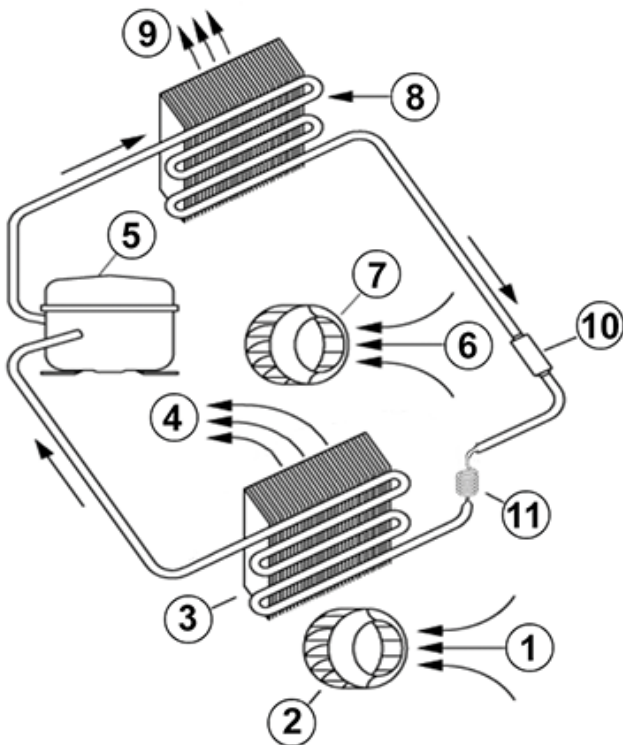

6. Technical data

Order Number	570800001
Cooling capacity L35L35	750 W @ 50 Hz 830 W @ 60 Hz
Cooling capacity L35L50	650 W @ 50 Hz 695 W @ 60 Hz
Compressor	Reciprocating compressor
Refrigerant / GWP	R134a / 1430
Refrigerant charge	234 g / 8 oz
High / low pressure	25 / 6 bar 362 / 88 psig
Temperature range	-40°C - +55°C
Air volume flow (system / unimpeded)	Ambient air circuit: 315 / 850 m ³ /h Cabinet air circuit: 165 / 250 m ³ /h
Mounting	External
Housing Material	Mild steel, powder coated
Dimension H x W x D	830 x 304 x 270 mm
Weight	30 kg
Cut out dimensions	265 x 180 265 x 160 mm
Voltage / Frequency	230 V ~ 50/60 Hz
Current L35L35	3.1 A
Starting current	10 A
Max. current	3.7 A
Nominal power L35L35	470 W
Max. power	580 W
Fuse	5 A (T)
Connection	Connection terminal block
Ingress protection	IP 56 / Type 12, 3, 3R, 4
Approvals	CE, cURus, cULus

7. Mounting



Always disconnect the power supply before opening the unit.

The heat load to be dissipated from enclosure should not exceed specific cooling output of the unit at any condition. At cooling unit selection always cater for a safety margin of at least 15% extra cooling output in the worst conditions. Air inlets and outlets must be completely free from obstruction.

Ensure that flows of air leaving and entering the cooling unit, internal and external, are not obstructed. Cooling unit enclosure air suction hole must be installed in the highest possible point. When installing the unit on a door ensure it can take the weight.

Before drilling the enclosure ensure the fixing elements and couplings will not interfere with the equipment inside the enclosure itself. Disconnect power before starting any work inside the enclosure. Following this 1:1 Scale Drilling Template drill the holes and make the required cuts on the enclosure. This template may have been affected by storage conditions, please check this template by verifying values of the largest dimensions before drilling. Fit the sealing strip on the cooling unit on the side connected to the enclosure and follow the installation diagram.

This AC unit can only be mounted to a suitably Type rated enclosure to maintain it's Type rating. The Type and IP rating of the enclosure should be the same or higher than that of the unit.

8. Mounting Principle

- 1 M6 bolts
- 2 M6 toothed washers
- 3 M6 Flat washers
- 4 Enclosure
- 5 Mounting gasket
- 6 Cooling unit

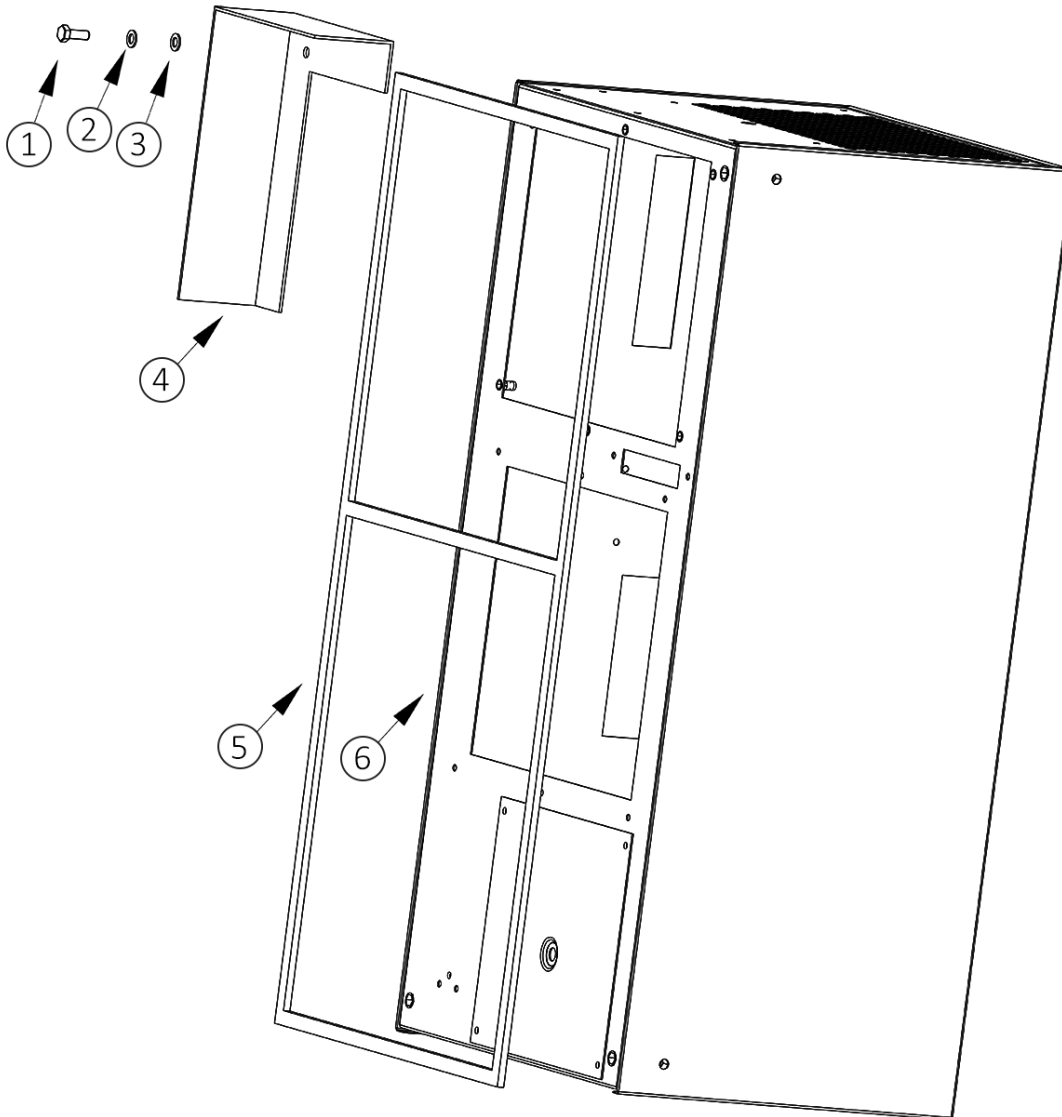

9. Dimensions (H x W x D)

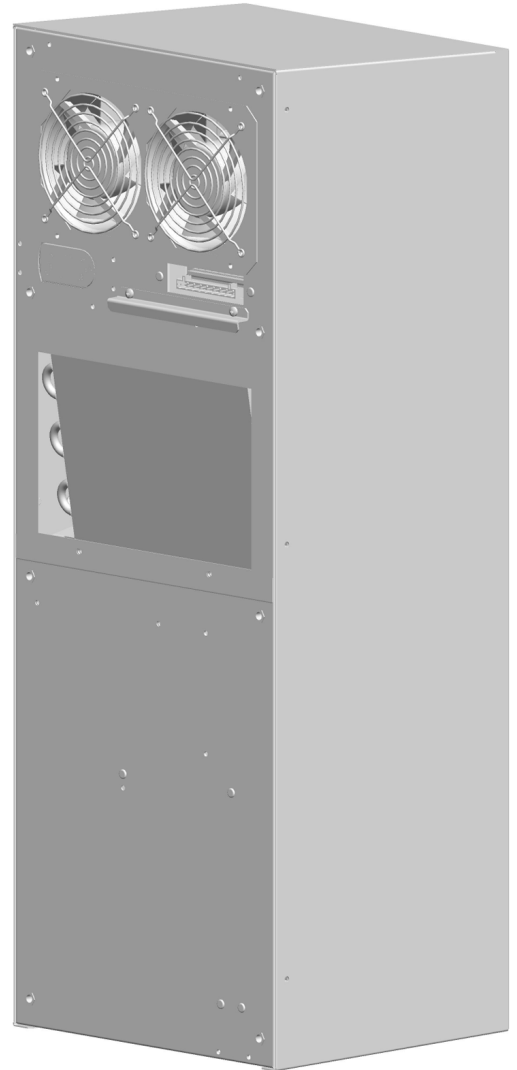
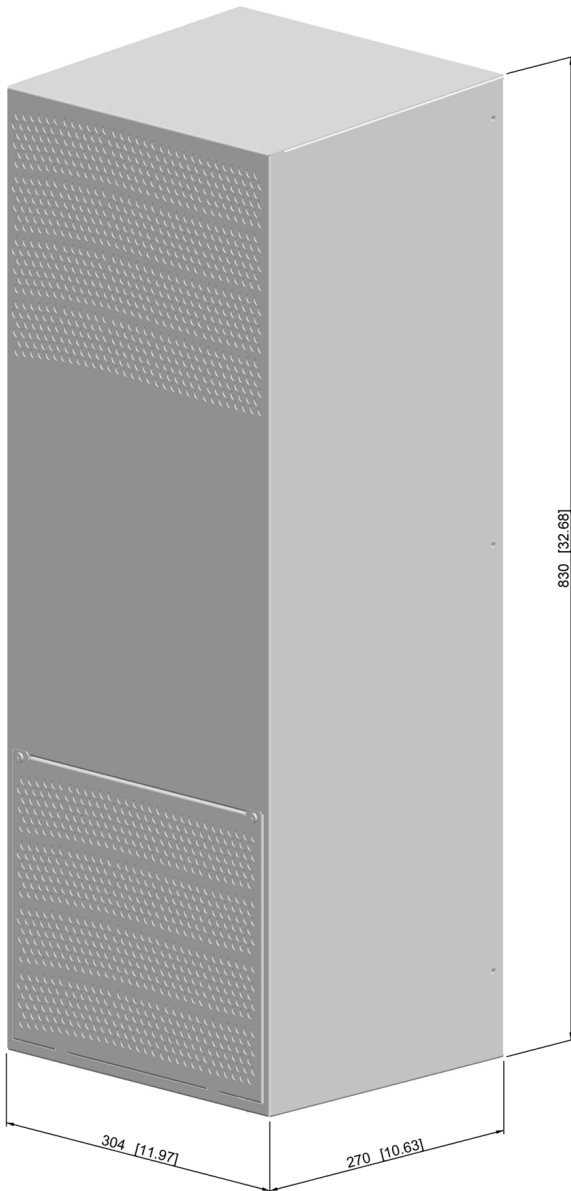

10. Electrical connection

Door Switch

The unit can be switched on and off via a door contact switch. When delivered the door contact terminals are bridged on the female connector. To connect the door contact switch remove the bridge and connect door contact switch. The contact must be closed when the cabinet door is closed.

Alarm Contacts

Alarm contacts rated according to:

EN60730-1 8(4)A N.O., 6(4)A N.C., 2(2)A N.O./N.C. @ 250Vac 100000 cycles

UL 873 8A resistive 2FLA 12LRA, pilot duty C300 @ 250Vac 30000 cycles

These contacts are not suitable for fluorescent loads (neon lights, etc.) that use starters (ballasts) with phase shifting capacitors. Fluorescent lamps with electronic controllers or without phase shifting capacitors can be used, depending on the operating limits specified for each type of relay.

11. Wiring diagram

- 1 L1
- 2 /
- 3 N
- 4 PE
- 5 Alarm (NO) P1
- 6 Alarm (COM) P2
- 7 Alarm (NC) P3
- 8 Door T1
- 9 Door T2

NOTES

- 1. Ci not used in 300-850W [1000-2890BTU].
- 2. Mi₁ used only in 550-850W [1870-2890BTU]
- 3. X1 used for 230V units, X2 used for 115/400-460V units.
- 4. Connected for units with internal heater.
- 5. Ma₁+Ca₁ for 4kW [13650BTU] only.

PART LIST

- Mc: Compressor
- Ma: Ambient fan
- Mi: Internal fan
- Cc: Comp. capacitor
- Ca: Amb. fan capacitor
- Ci: Int. fan capacitor
- Sa: NTC sensor for ambient temperature
- Si: NTC sensor for internal temperature

X4 ELECTRICAL SUPPLY CONNECTION

- (see unit typeplate for unit voltage)
- 115/230V - 1: L1(115/230V), 3:N
- 400V - 2:LX(400V), 3:L2(400V)
- 460V - 1:L1(460V), 3:L2(460V)

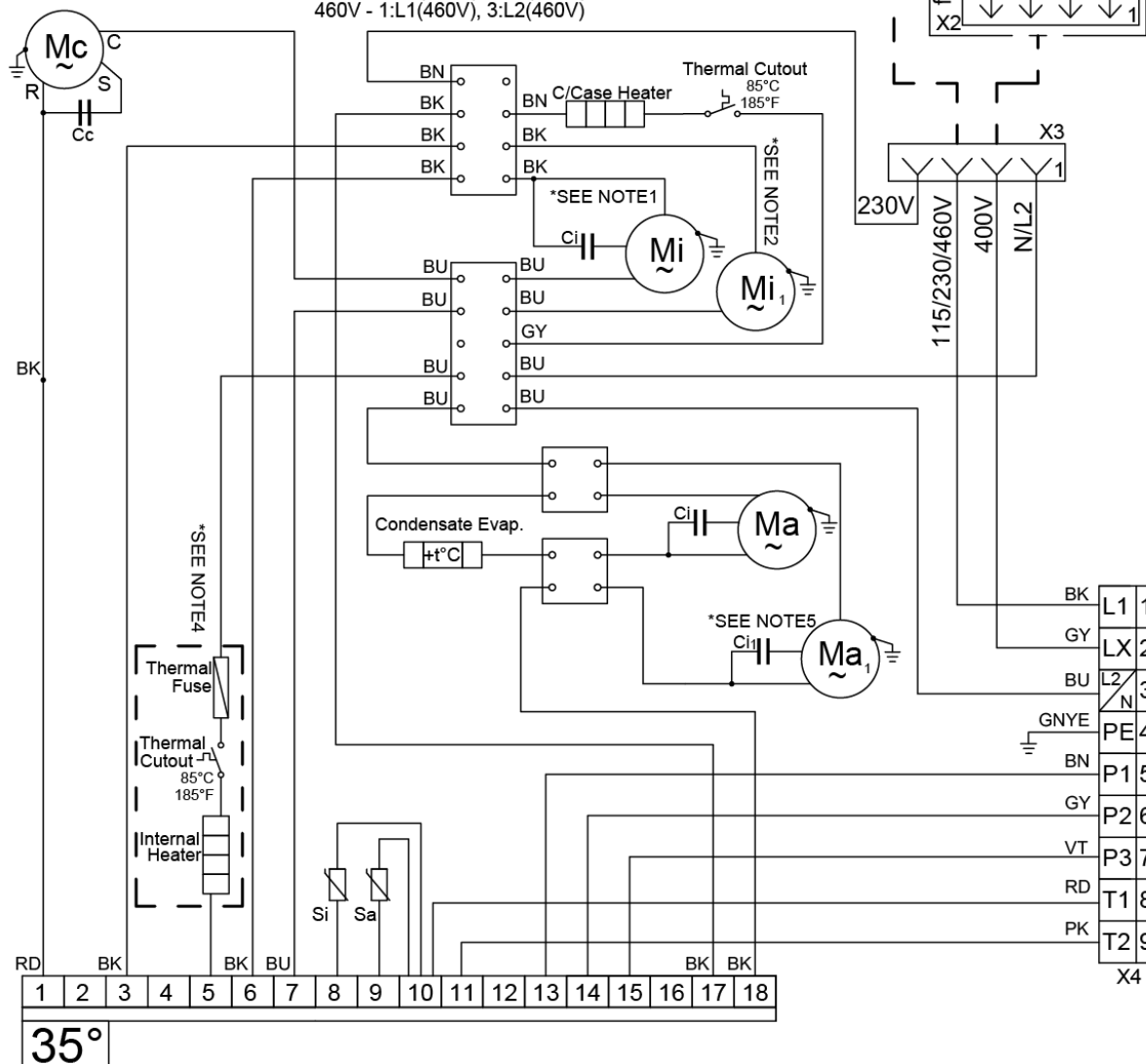
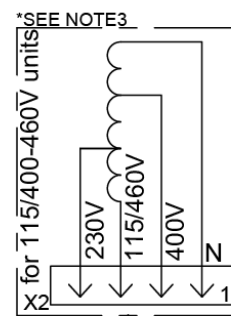
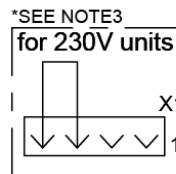

5960030633/c

12. Taking into operation

Attention!

The unit can be damaged by lack of lubricant. To ensure that the compressor is adequately lubricated the oil, which has been displaced during transport, must be allowed to flow back into it. The unit must therefore be allowed to stand for at least 30 min. before being connected to the mains and taken into operation.

The unit / system must be protected with a MCB Type D or K.

Upon connection the internal fan will start working. If the temperature inside the enclosure is higher than the set value of the controller both the compressor and external air fan start working. Once the air inside the enclosure reaches the set temperature the compressor and external fan will stop.

The unit is pre-set at 35°C, which is suitable for most of the electronic devices.

13. Trouble shooting

Failure	Condition	Cause	Solution
Unit doesn't cool	Internal fan does not work	Power not connected.	Verify power supply
	Internal fan works, external fan and compressor don't work	Enclosure temperature is below setting temperature (St)	Verify values of parameter "St"
		Door switch contact is open	Verify door switch
	Controller doesn't work	Replace controller	
Unit doesn't cool	Internal fan works, external fan and compressor don't work. Display shows alternating OFF and temperature	The sequence of the phases inside the power supply connector is incorrect	Change phases inside power supply connector
		Compressor motor electrical failure	Have compressor replaced by qualified service technician
	External and internal fan work, compressor does not work	Capacitor for compressor failed	Replace capacitor
Unit doesn't cool	Compressor works, external fan doesn't work	External fan needs to be replaced	Replace external fan
	Enclosure temperature too hot	Compressor and fans (external and internal) work all the time	Cooling unit undersized
Compressor and external fan work in alternating mode (ON / OFF)		Thermal compressor protector triggered	Verify if ambient temperature is too high, clean condenser
	Refrigerant leakage	Contact dealer/service center	
Excessive condensate	Enclosure door open	Ambient air gets into the enclosure	Ensure door is closed, add a door switch and connect it to controller
	Enclosure door closed	Enclosure IP protection class is below IP54	Seal all openings of the enclosure
		Damaged or misplaced sealing strip	Repair sealing strip accordingly

14. Maintenance & Cleaning



Always switch power supply off before starting any maintenance on the unit.

The cooling unit is generally maintenance free and can be operated without filters in most environments. For units with filters these should be checked, cleaned and if necessary replaced on a regular basis. In addition the unit should have regular functional tests (approx. every 2,000 hours depending on the grade of ambient pollution).

Disposal.

The cooling unit contains R134a refrigerant and small quantities of lubricating oil. Replacement, repairs and final disposal must be done according to the regulations of each country for these substances.

15. Transport & Storage

Malfunction due to transport damage

On delivery the carton box containing the unit must be examined for signs of transport damage. Any transport damage to the carton box could indicate that the unit itself has been damaged in transit which in the worst case could mean that the unit will not function.

The unit can only be stored in locations which meet the following conditions:

- temperature range: - 40°C to + 70°C
- Relative humidity (at 25°C): max. 95 %

Returning the unit

To avoid transport damage the unit should be returned in the original packing or in a packing case and must be strapped to a pallet. If the unit cannot be returned in the original packing please ensure that:

- A space of at least 30 mm. must be maintained at all points between the unit and the external packing.
- The unit must be shipped in the same position as it was mounted.
- The unit must be protected by shock resistant padding (hard foam corner pieces, strips or cardboard corner pieces)

16. Parts supplied

1 x Cooling unit with individual packaging

1 x Plastic bag containing:

- Instruction manual with technical information
- CE Conformity Declaration
- Drilling template in 1:1 scale, including general information about the unit

1 x Installation pack containing:

8 x M6 Bolts

8 x A6.4 Toothed Washers

8 x A6.4 Washers

1 x Female connector with shorted wired positions for door contact

Seifert Systems GmbH

Albert - Einstein Str. 3

42477 Radevormwald

Deutschland

Tel. +49 2195 68994-0

Fax +49 2195 6899420

info.de@seifertsystems.com

Seifert Systems Ltd.

HF09/10

Hal-Far Industrial Estate

Birzebbuga, BBG 3000

Malta

Tel. +356 2220 7000

Fax +356 2165 2009

info@seifertsystems.com

Seifert Systems AG

Wilerstrasse 16

4563 Gerlafingen

Switzerland

Tel. +41 32 675 35 51

Fax +41 32 675 44 76

info.ch@seifertsystems.com

Seifert Systems Inc.

75 Circuit Drive

North Kingstown

RI 0285

USA

Tel. +1 401-294-6960

Fax +1 401-294-6963

info.us@seifertsystems.com

Seifert Systems Pty Ltd.

105 Lewis Road

Wantirna South

3152 Victoria

Australia

Tel. +61 3 98 01 19 06

Fax. +61 3 98 87 08 45

info@seifertsystems.com.au